



RESCUE BASKET



- 96" x 42" Rescue Man Basket
- Designed to Fit Ambulance Gurneys / Stretchers
- 1,000 LBS. Capacity
- 4 Tie Down Points
- Secure Locking Swing Out Door w/ Safety Pin
- Braced Doorway Arch to Maintain Structural Strength
- 4 Crane Hook Points
- 4 Hook Points Underneath for Test Weight & Tag Lines
- Fork Pockets for Transporting
- Large Reflective EMERGENCY RESCUE Lettering
- Meets or Exceeds OSHA & ANSI Regulations



Tie Down Point



Locking Door



Doorway Brace

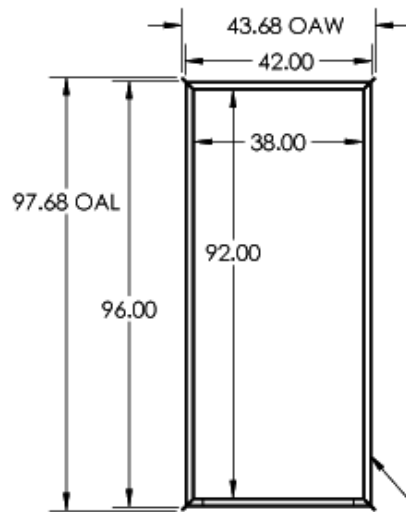

Swing Out Door with Drop Lock Pin through base
Drop Lock Pin secured with safety pin.

CAPACITY: 1,000 LBS.

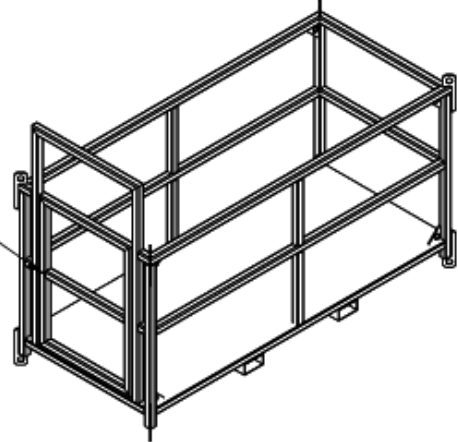

Frame : 2" sq tube
Base : 1/8" diamond plate

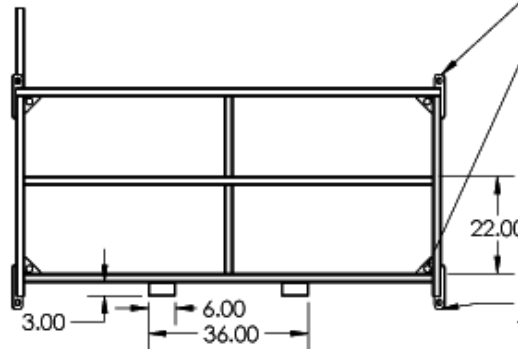
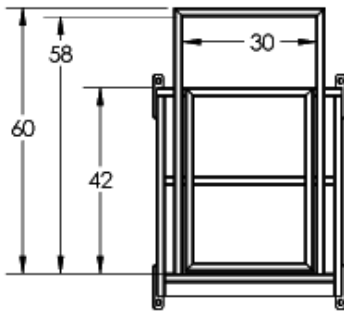

(4) Lifting hook points

(4) strap down points

(4) Bottom Lifting Points for test weight & Tag Lines

KOKE Inc.

96x42 Rescue Crane Basket

PROPRIETARY AND CONFIDENTIAL

THE INFORMATION CONTAINED IN THIS DRAWING IS THE SOLE PROPERTY OF KOKE INC. ANY REPRODUCTION IN PART OR AS A WHOLE WITHOUT THE WRITTEN PERMISSION OF KOKE INC IS PROHIBITED.

MATERIAL

steel

FINISH

Drawn By: Richard Koke

10/4/13

DIMENSIONS ARE IN INCHES

TOLERANCES:

FRACTIONAL: ±1/16

ANGULAR: MATCH BEND ±1 deg

TWO PLACE DECIMAL: ±.05

THREE PLACE DECIMAL: ±.005

SIZE

DWG. NO.

MBR-9642

REV.

SCALE: 1:1

WEIGHT:

SHEET 1 OF 1

- Rugged Heavy Duty Construction
- Diamond Plate Anti-Skid Floor
- All Welded Construction
- 38"W x 92"L ID Floor Space
- 30"W x 58"H Door Opening
- 4 Lanyard Hook Points
- 42"H Rails w/ Mid-Rail
- Mesh Enclosed Lower Half
- Special Sizes & Features Available Upon Request